

X2 pro

Beijer  
ELECTRONICS

# X2 series

Strong. Stylish. Smart.

# X2 series

Strong. Stylish. Smart.

The X2 series is the powerful range of HMI panels from Beijer Electronics. The X2 product families combine great design with strong performance to power your HMI solutions. Create smart integrated solutions boosted by iX HMI software.



## One family, one great design

X2 panels offer a slim, modern design. Consistent across the entire range, adding visual quality to your solution.

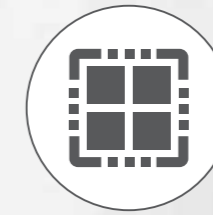

## All the performance you need

Power-efficient ARM9 processors all the way up to the latest quad core ARM Cortex-A9 processors deliver fast program execution and screen change. It gives you all the performance you need.

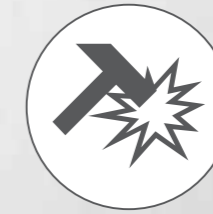

## Robust reliability

The robust die cast aluminum body offers great resistance to mechanical stress. We've redesigned the electronics and made other improvements to further enhance solid operation.



## Prepared for any environment

X2 panels operate in wide temperature ranges. They offer strong ingress protection and in addition, they hold all the certificates you need to perform in the field.



## Control by BCS Tools

BCS Tools is the CODESYS-based software platform enabling X2 to perform additional integrated IEC 61131-3 PLC functionality with safe and fast program execution.



## A simple path forward

It's easy to upgrade your existing iX HMI solution to the X2 series.



## 2 year warranty

We offer a two-year standard warranty for all operator panels in the X2 series.



Our X2 HMI panels are now IIoT ready by standard and fully prepared to enable you to move your machine data to the cloud.

# A match for every requirement

The X2 series matches almost every requirement and lets you choose from a powerful range of more than 50 models and additional options.

## X2 extreme

Rugged HMI panels for tough environments  
Available in 7, 12 and 15 inches, all in 3 versions: Panel mount standard and high-performance versions, and fully sealed high-performance versions. All high-performance versions offer high brightness display and optional integrated CODESYS-based PLC functionality.

## X2 control

Integrated CODESYS-based control  
Available in 4, 7, 10, 12 and 15 inches.



## X2 web

with built-in HTML5 web client  
X2 pro web is available in 7, 10 and 15 inches and X2 extreme web is available in 7, 12 and 15 inches.

## X2 base

Cost-effective, full functionality HMI panels  
Available in 5, 7 and 10 inches and in 7, 10, 15 inches high-performance versions.

## X2 marine

Built for life at sea  
Available in 7 and 15 inches with optional high brightness display and integrated CODESYS-based PLC functionality.

## X2 pro

High performance HMI panels for all automation needs  
Available in 4, 7, 10, 12, 15 and 21 inches.



# X2 base

## New versions of cost-effective, full functionality HMI panels

The X2 base family is now updated with the new range of X2 base v2 HMIs offering improved performance, more display sizes and an additional range of high-performance HMIs. The X2 base v2 panels are cost-effective industrial HMIs with high-resolution touch-screens and modern design. The HMIs combine IP65 corrosion resistant plastic housing with the full version of the iX software, providing a cost-effective yet advanced HMI solution for small to medium applications.

X2 base v2 HMIs are available in 5, 7 and 10 inches and in 7, 10 and 15 inches high-performance versions.

The high-performance versions are scheduled for launch in 2021.



See page 20 for technical data.

### Features X2 base

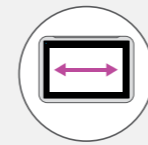

**Wide screen format**  
X2 panels offer wide screen format, designed to succeed the traditional 4:3 square aspect ratio.



**UL, CE, FCC and KCC certificates**  
The entire X2 range offers a strong standard certification with UL, CE, FCC and KCC certificates.



**iX software – why you'll love our hardware**  
The iX software gives you smart communication tools. iX combines top-class vector graphics and easy-to-use functions that provide reliable operation, and almost limitless connectivity to your other equipment.



**Custom design or non-branded**  
Profile your brand or go for neutral. X2 panels offer custom designed or non-branded front foils, as alternatives to the standard Beijer Electronics branded versions.

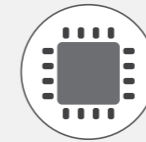

**Power efficient ARM9 processors**  
Power efficient ARM9 processor provides strong performance for small and medium sized applications.



**Corrosion resistant plastic housing**  
Corrosion resistant plastic housing with IP65, NEMA 4X/12 and UL Type 4X/12 front.



**Operating temperature -10°C to +50°C**  
The -10°C to +50°C operating temperature range satisfies the demands of most industries.



**All the communication ports you need**  
X2 base offers 1 × Ethernet, 4 × serial, 1 × USB as standard, securing ample communication with other equipment.

# X2 pro

## High performance HMI panels for all automation needs

X2 pro includes a range of high performance industrial panels designed for demanding applications. All with the high performance of powerful ARM Cortex-A9 processors, the latest screen technology and a wide range of connectivity options to cover all your automation needs.

X2 pro panels are available in 4, 7, 10, 12, 15 and 21 inches.

The X2 pro family additionally offers web HMIs perfect for enterprises and users who want to utilize HTML5 web technologies in industrial environments, see page 16.



See page 22-23 for technical data.

### Features X2 pro

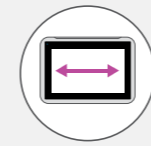

**Wide screen format**  
X2 panels offer wide screen format, designed to succeed the traditional 4:3 square aspect ratio.



**UL, CE, FCC and KCC certificates\***  
The entire X2 range offers a strong standard certification with UL, CE, FCC and KCC certificates.



**iX software – why you'll love our hardware**

The iX software gives you smart communication tools. iX combines top-class vector graphics and easy-to-use functions that provide reliable operation, and almost limitless connectivity to your other equipment.



**Custom design or non-branded**

Profile your brand or go for neutral. X2 panels offer custom designed or non-branded front foils, as alternatives to the standard Beijer Electronics branded versions.

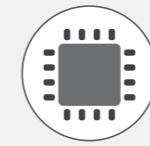

**Powerful ARM Cortex-A9 processor**  
Powerful single or dual core ARM Cortex-A9 processor delivers

fast screen changes and program execution in demanding applications.



**Robust aluminum housing**

Robust aluminum housing with IP65, NEMA 4X/12 and UL Type 4X/12 front. Resistant to direct rain, snow or wash-downs, dirt, grime and dust.



**Wide operating temperature -10°C to +60°C\***

The wide -10°C to +60°C operating temperature range satisfies the demands of most industries.



**Marine certifications\***

The X2 panels meet extended classes of marine certifications not normally carried by HMIs, making them suitable for all onboard locations.



**Internal CANopen and optional bus modules**

It's easy to interface with controllers using the internal CANopen bus or optional CiX CAN, Profibus or MPI modules.



**SD memory card**

Card holder and USB connection are located behind the lid on the back of the panel for smart memory expansion, project backup and application loading.

\*X2 pro 21 offers UL, CE and FCC and certificates, no marine certifications and a temperature range of 0°C to +50°C.

# X2 marine

Built for life at sea

X2 marine offers user-friendly, reliable operation offshore, on ships and in other maritime applications. With black frame and nautical society certifications, X2 marine panels are suitable for mounting on the bridge, in the engine room and inside cabins. X2 marine panels are available with optional high brightness display and integrated CODESYS PLC functionality.

*X2 marine panels are available in 7 and 15 inches with optional high brightness display and integrated CODESYS-based PLC functionality.*



## Features X2 marine

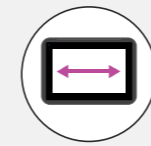

**Wide screen format**  
X2 panels offer wide screen format, designed to succeed the traditional 4:3 square aspect ratio.



**UL, CE, FCC and KCC certificates**  
The entire X2 range offers a strong standard certification with UL, CE, FCC and KCC certificates.



**iX software – why you'll love our hardware**  
The iX software gives you smart communication tools. iX combines top-class vector graphics and easy-to-use functions that provide reliable operation, and almost limitless connectivity to your other equipment.



**Custom design or non-branded**  
Profile your brand or go for neutral. X2 panels offer custom designed or non-branded front foils, as alternatives to the standard Beijer Electronics branded versions.

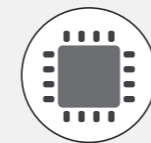

**Powerful ARM Cortex-A9 processor**  
Powerful single, dual or quad core ARM Cortex-A9 processor delivers fast screen changes and program execution in demanding applications.



**Robust aluminum housing**  
Robust aluminum housing with IP65, NEMA 4X/12 and UL Type 4X/12 front. Resistant to direct rain, snow or wash-downs, dirt, grime and dust.

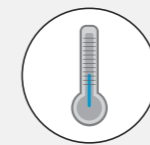

**Wide operating temperature -10°C to +60°C**  
The wide -10° to +60°C operating temperature range satisfies the demands of most industries.



**Marine certifications**  
The X2 panels meet extended classes of marine certifications not normally carried by HMIs, making them suitable for all onboard locations.



**Internal CANopen and optional bus modules**  
It's easy to interface with controllers using the internal CANopen bus or optional CiX CAN, Profibus or MPI modules.



**SD memory card**  
Card holder and USB connection are located behind the lid on the back of the panel for smart memory expansion, project backup and application loading.



**Dimmable backlight**  
Comfortable and safe operation in high and low ambient light. Backlight is continuously dimmable to very low brightness.

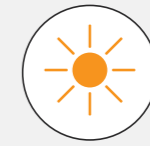

**High brightness display**  
Optional 1,000 cd/m<sup>2</sup> backlight provides excellent readability in high ambient light levels such as sunlight.



**Add control by BCS Tools**  
BCS Tools is the CODESYS-based software platform enabling SC versions to perform powerful integrated IEC 61131-3 PLC functionality. Just add remote I/Os for a scalable, cost-effective solution.

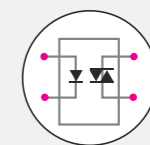

**Built-in digital outputs**  
X2 marine panels with high brightness option have built-in digital outputs for direct connection of alarms, signal lights, etc.



**Internal isolation**  
Internal isolation conforms to marine standards for both burst and surge immunity.

See page 21 for technical data.

# X2 control

## Integrated CODESYS control

X2 control panels combine industrial HMI and CODESYS-based PLC functionality in the same compact hardware. Panels range from ultra-compact 4-inch to 15-inch panels designed for demanding applications. Add standard distributed I/Os and you'll get an elegant, scalable and cost-effective solution that's cutting-edge.

X2 control panels are available in 4, 7, 10, 12 and 15 inches.



See page 24-25 for technical data.

### Features X2 control

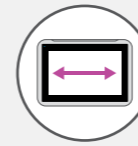

**Wide screen format**  
X2 panels offer wide screen format, designed to succeed the traditional 4:3 square aspect ratio.



**UL, CE, FCC and KCC certificates**  
The entire X2 range offers a strong standard certification with UL, CE, FCC and KCC certificates.



**iX software – why you'll love our hardware**  
The iX software gives you smart communication tools. iX combines top-class vector graphics and easy-to-use functions that provide reliable operation, and almost limitless connectivity to your other equipment.



**Custom design or non-branded**  
Profile your brand or go for neutral. X2 panels offer custom designed or non-branded front foils, as alternatives to the standard Beijer Electronics branded versions.



**Powerful ARM Cortex-A9 processor**  
Powerful dual or quad core ARM Cortex-A9 processor delivers fast screen changes and program execution in demanding applications.



**Robust aluminum housing**  
Robust aluminum housing with IP65, NEMA 4X/12 and UL Type 4X/12 front. Resistant to direct rain, snow or wash-downs, dirt, grime and dust.



**Wide operating temperature -10°C to +60°C**  
The wide -10°C to +60°C operating temperature range satisfies the demands of most industries.



**Marine certifications**  
The X2 panels meet extended classes of marine certifications not normally carried by HMIs, making them suitable for all onboard locations.



**Internal CANopen and optional bus modules**  
It's easy to interface with controllers using the internal CANopen bus or optional CiX CAN, Profibus or MPI modules.

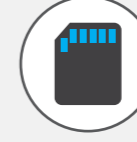

**SD memory card**  
Card holder and USB connection are located behind the lid on the back of the panel for smart memory expansion, project backup and application loading.

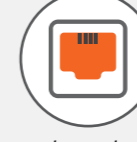

**2 Ethernet ports as standard**  
Panels have two built-in Ethernet ports as standard for communication with other equipment.



**EtherCAT as standard**  
X2 panels support communication with super-fast EtherCAT as standard.



**Control by BCS Tools**  
BCS Tools is the CODESYS-based software platform enabling X2 control to perform powerful integrated IEC 61131-3 PLC functionality. Just add remote I/Os for a scalable, cost-effective solution.

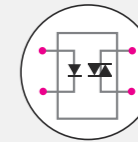

**Built-in digital outputs**  
10, 12 and 15 inch panels have built-in digital outputs for direct connection of alarms, signal lights, etc.



**Configuration freedom**  
Applications remain elegantly slim with integrated control in the panel. Add remote I/Os to fit your needs, and select between three major fieldbuses – EtherCAT, Modbus RTU and Modbus TCP.



**Less risk of error with one system**  
Two separate PLC and HMI systems mean twice the risk of error. X2 control changes all that. Simply configure your system with WARP and you're done. It's never been easier to create applications.

# X2 extreme

## Rugged HMI panels for tough environments

X2 extreme panels are certified by all major classification societies. Designed to perform in rugged outdoor environments and in hazardous areas where gases, vapors and dust are present. Extended environmental capabilities include operating temperatures from -30°C to +70°C, high vibrations and high-pressure wash-downs.

X2 extreme panels are available in 7, 12 and 15 inches, all in 3 versions: Panel mount standard and high-performance versions, and fully sealed high-performance versions. All high-performance versions offer high brightness display and optional integrated CODESYS-based PLC functionality.

The X2 extreme family additionally offers web HMIs perfect for enterprises and users who want to utilize HTML5 web technologies in industrial environments, see page 16.



See page 26-29 for technical data.

### Features X2 extreme

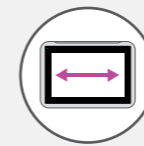

**Wide screen format**  
X2 panels offer wide screen format, designed to succeed the traditional 4:3 square aspect ratio.



**UL, CE, FCC and KCC certificates**  
The entire X2 range offers a strong standard certification with UL, CE, FCC and KCC certificates.



**iX software – why you'll love our hardware**  
The iX software gives you smart communication tools. iX combines top-class vector graphics and easy-to-use functions that provide reliable operation, and almost limitless connectivity to your other equipment.



**Custom design or non-branded**  
Profile your brand or go for neutral. X2 panels offer custom designed or non-branded front foils, as alternatives to the standard Beijer Electronics branded versions.

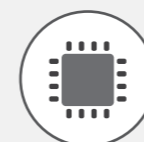

**Powerful ARM Cortex-A9 processor**  
Powerful dual or quad core ARM Cortex-A9 processor delivers fast screen changes and program execution in demanding applications.



**Robust aluminum housing**  
Robust aluminum housing with IP66 front. Resistant to direct rain, snow or high-pressure washdowns, dirt, grime and dust.



**Extreme operating temperature -30°C to +70°C**  
Extreme -30°C to +70°C operating temperature range guarantees trouble-free use in the harshest environments.



**Marine certifications**  
The X2 panels meet extended classes of marine certifications not normally carried by HMIs, making them suitable for all onboard locations.



**Internal CANopen bus**  
It's easy to interface with controllers using the internal CANopen bus.



**SD memory card**  
Card holder and USB connection are located behind the lid on the back of the panel for smart memory expansion, project backup and application loading.



**Dimmable backlight**  
Comfortable and safe operation in high and low ambient light conditions. Backlight is continuously dimmable to very low brightness.



**High brightness display**  
All high-performance versions feature 1,000 cd/m<sup>2</sup> backlight providing excellent readability in high ambient light levels such as sunlight.



**Add control by BCS Tools**  
BCS Tools is the CODESYS-based software platform enabling SC versions to perform powerful integrated IEC 61131-3 PLC functionality. Just add remote I/Os for a scalable, cost-effective solution.



**Certified for hazardous environments**  
Certified for use in hazardous areas where gases, vapors and dust are present.



**Internal isolation**  
Internal isolation conforms to marine standards for both burst and surge immunity.



**High vibration**  
Panels are tested to 4 g RMS sweep sine for vibration and 40 g 11 ms half sine for shock.



**Panel mount**  
Panel mount versions hold IP66, NEMA 4X/12 and UL Type 4X/12 ingress protection rating for the front and conform to ATEX Zone 2 and ATEX Zone 22 certification.

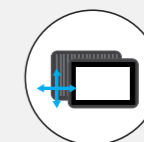

**Fully sealed**  
Fully sealed versions with M12 connectors with IP66 ingress protection rating and ATEX/IECEx Zone 2 and Zone 22 (IP65) certification.



# X2 web

## HMI panels with built-in HTML5 web client

The X2 web HMI panels within the X2 pro and X2 extreme families are perfect HMIs for enterprises and users who want to utilize HTML5 web technologies in industrial environments. The X2 web HMIs offer visualization with Chromium Kiosk mode operation of single browser window web pages from SCADA systems, PLCs or other devices with built-in web servers.

*The X2 web HMIs enable enterprises and users to visualize the same web content across different target platforms such as HMI, mobile, tablet, pc, etc. without any conversion or re-engineering. The X2 web HMIs have the same industrial grade quality hardware as the iX based X2 pro and X2 extreme HMIs offering extensive certification and environmental durability.*



See page 30-31 for technical data.

### Features X2 web

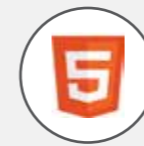

#### HTML5 visualization

Perfect HMIs for enterprises and users who want to utilize HTML5 web technologies in industrial environments.

technologies in industrial environments.

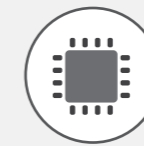

#### Powerful ARM Cortex-A9 processor

Powerful dual or quad core ARM Cortex-A9 processor delivers fast screen changes and program execution in demanding applications.

fast screen changes and program execution in demanding applications.

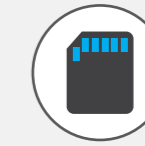

#### SD memory card

Card holder and USB connection are located behind the lid on the back of the panel for smart memory expansion, project backup and application loading.

for smart memory expansion, project backup and application loading.

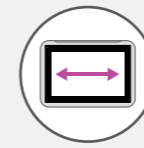

#### Wide screen format

X2 panels offer wide screen format, designed to succeed the traditional 4:3 square aspect ratio.

X2 panels offer wide screen format, designed to succeed the traditional 4:3 square aspect ratio.



#### Robust aluminum housing

Robust aluminum housing with IP65, NEMA 4X/12 and UL Type 4X/12 front (X2 pro web). IP66 front (x2 extreme web).

Robust aluminum housing with IP65, NEMA 4X/12 and UL Type 4X/12 front (X2 pro web). IP66 front (x2 extreme web).



#### Certified for hazardous environments

Certified for use in hazardous areas where gases, vapors and dust are present (X2 extreme web).

Certified for use in hazardous areas where gases, vapors and dust are present (X2 extreme web).



#### UL, CE, FCC and KCC certificates

The entire X2 range offers a strong standard certification with UL, CE, FCC and KCC certificates.

The entire X2 range offers a strong standard certification with UL, CE, FCC and KCC certificates.

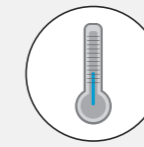

#### Wide operating temperature

Operating temperature of -10°C to +60°C (X2 pro web) and -30°C to +70°C (X2 extreme web) satisfies the demands of most industries.

Operating temperature of -10°C to +60°C (X2 pro web) and -30°C to +70°C (X2 extreme web) satisfies the demands of most industries.



#### Internal isolation

Internal isolation conforms to marine standards for both burst and surge immunity.

Internal isolation conforms to marine standards for both burst and surge immunity.



#### Custom design or non-branded

Profile your brand or go for neutral. X2 panels offer custom designed or non-branded front foils, as alternatives to the standard Beijer Electronics branded versions.

Profile your brand or go for neutral. X2 panels offer custom designed or non-branded front foils, as alternatives to the standard Beijer Electronics branded versions.



#### Marine certifications

The X2 panels meet extended classes of marine certifications not normally carried by HMIs, making them suitable for all onboard locations.

The X2 panels meet extended classes of marine certifications not normally carried by HMIs, making them suitable for all onboard locations.



#### High vibration

Panels are tested to 4 g RMS sweep sine for vibration and 40 g 11 ms half sine for shock.

Panels are tested to 4 g RMS sweep sine for vibration and 40 g 11 ms half sine for shock.

# iX software – why you’ll love our hardware

The iX software gives you smart communication tools. It combines top-class vector graphics and easy-to-use functions that provide reliable operation, and almost limitless connectivity to your other equipment.



## Efficient workflow

Speed up engineering in an intuitive development environment filled with shortcuts. Pre-styled objects, a customizable workspace, a component library and a smart property grid are some of the features that’ll boost your workflow. Share your customized objects and advanced script modules with colleagues.

## Complete HMI functionality

It’s easy to get your application up and running. All essential functions you need are included such as data logging, recipes, alarms, trends and audit trail. Take advantage of ready-made objects with built-in functionality, vector-based symbols and graphics that can be easily inserted into the screen.

## Functionality for advanced users

iX has support for .NET technology, providing options to design specialized functionality. Use C# scripting or .NET components. Take advantage of third party objects and import .NET assemblies to extend the functionality

further. Control and exchange data with multiple controllers and enjoy connectivity via FTP, OPC and web.

## Connect to all automation brands

An extensive driver list enables communication with hundreds of unique PLCs and automation equipment from all major manufacturers. Share information easily between users and have safe control of complex systems, even over long distances. Transfer files and control panels remotely with FTP and VNC servers.



# Get insights from the cloud with acirro+

Move your machine data to the cloud with our fully IIoT ready X2 HMIs and BoX2 devices, and gain insights to streamline operations.



If you are a Maker of Things, a machine builder or a provider of other technical equipment, your business runs on data. Data that can tell when your machines are running efficiently and indicate when you need to introduce maintenance or other measures.

The threshold to accelerating into digital has never been lower than now, closing the gap between OT and IT.

Our X2 HMIs and BoX2 devices are now IIoT ready by standard and fully prepared to enable you to move your machine data to the cloud.

Easily set up a secure cloud connection and begin moving machine data to the cloud using our acirro+ IIoT platform. The solution is easy to implement without needing to rewire your existing installation or re-program an existing application.

Viewing machine data in visual dashboards gives you a great overview and provides insights to streamline your machine’s operation, creating new business opportunities.

## ACCELERATE TO DIGITAL NOW!

## The safe and secure IIoT solution



### Securely transmitted data

Your machine data is securely transmitted to the Beijer Electronics cloud using bank-level security SSL/TLS encryption.



### No unauthorized access

All communication from devices to the cloud is outbound. Devices are never visible on the public internet, minimizing the risk of unauthorized access.



### Identified devices only

All X2 HMIs and BoX2 gateways have an X.509 standard certificate tied to their serial number. Each device has a traceable, unique identity to identify just your devices in the cloud.



### Safe hosting

All data is hosted on Microsoft Azure with highly secure administration of organization, users devices, device groups, cloud tags, etc. via acirro+.



### Download iX HMI software

Go to [smartstore.beijerelectronics.com](http://smartstore.beijerelectronics.com) and try out the free demo version of iX.



### Learn more

Go to [www.beijerelectronics.com/acirroplus](http://www.beijerelectronics.com/acirroplus) and learn more about our cloud-based IIoT platform.



	X2 base 5 v2*	X2 base 7 v2 (HP)*	X2 base 10 v2 (HP)*	X2 base 15 v2 (HP)*
<b>General description</b>				
Part number	630005110	630005210 (630009510)	630005310 (630009610)	630009810
Warranty	2 year			
<b>Certifications</b>				
General	CE, FCC, KCC, UL 61010-2-201			
<b>Mechanical</b>				
Mechanical size	173 x 109 x 37mm	202 x 152 x 37mm	290 x 193 x 40mm	409 x 270 x 43mm
Mounting option	Panel Mount			
Number of touches	1million finger touch operations			
Touch type	Resistive			
Cut-out size	161 x 93mm	186 x 136mm	275 x 177mm	393 x 254mm
Weight	0.32 kg	0.58 kg	0.86 kg	2.46 kg
Housing material	Plastic (PC+ABS), Gray			
<b>Power</b>				
Input voltage	24 V DC (18 to 32 VDC)			
Power consumption, max	4.8 W	5.7 W (6.6 W)	6.8 W (7.7 W)	17.3 W
Input fuse	Internal DC fuse			
<b>System</b>				
CPU	ARM Cortex A8 600MHz	ARM Cortex A8 600MHz (ARM Cortex A8 1000MHz)		ARM Cortex A8 1000MHz
RAM	512 MB			
FLASH	2 GB, 1.5 GB free	2 GB, 1.5 GB free		2 GB, 1.5 GB free
<b>Software</b>				
Operating system	Windows Embedded CE 8.0			
<b>Display</b>				
Size diagonal	5.0" diagonal	7.0" diagonal	10.1" diagonal	15.6" diagonal
Resolution	800 x 480 pixel (5:3)		1024 x 600 pixel (17:10)	1366 x 768 pixel (16:19)
Backlight	LED Backlight			
Backlight life time	20 000 hours		30000 hours	50000 hours
Backlight brightness	250 cd/m <sup>2</sup>	400 cd/m <sup>2</sup>	350 cd/m <sup>2</sup>	300 cd/m <sup>2</sup>
Backlight dimming	Industrial Dimming			
Display type	TFT-LCD with LED backlight			
<b>IOs</b>				
Digital output	No			
<b>Communication serial</b>				
Number of serial ports	1port9pinDsub, 1port3pinScrew (HP: 2port9pinDsub, 1port3pinScrew)			
Serial port 1	RS 232 (RTS/CTS)			
Serial port 2	RS422/485			
Serial port 3	RS 485			
Serial port 4	HP only: RS 232 (RTS/CTS)			
Serial port 5	HP only: RS422/485			
Serial port 6	RS485			
<b>Ethernet communication</b>				
Number of ethernet ports	1	1 (HP:2)		2
Ethernet port 1	1x10/100 Base-T (shielded RJ45)			
Ethernet port 2	NA	NA (1x10/100 Base-T (shielded RJ45))		
<b>Expansion interface</b>				
Expansion port	No			
SD card	No	No (Yes)		Yes
USB	1 (HP: 2)			
<b>Environmental</b>				
Operating temperature	-10°C to +50°C			
Storage temperature	-20°C to +60°C			
Shock	15g, half-sine, 11ms according to IEC60068-2-27			
Vibration	1g, according to IEC 60068-2-6, Test Fc			
Sealing front	IP65			
Sealing back	IP20			
Humidity	5% – 85% non-condensed			

\*Preliminary data. The high-performance versions are scheduled for launch in 2021.



	X2 marine 7 (HB, SC, HB SC)	X2 marine 15 (HB, SC, HB SC)
<b>General description</b>		
Part number	630002505 (HB: 630008705, SC: 630008605, HB SC: 630008805)	640003305 (HB: 640003505, SC: 640009005, HB SC: 640009405)
Warranty	2 year	
<b>Certifications</b>		
General	CE, FCC, KCC	
Marine	BV, DNV GL, KR, LR, ABS, CCS, EN60945, NK	
UL	UL 61010-2-201	
<b>Mechanical</b>		
Mechanical size	204 x 143 x 50mm	410 x 286 x 61mm
Touch type	Resistive	
Cut-out size	189 x 128mm	394 x 270mm
Weight	0.8 kg	3.85 kg
Housing material	Powder-coated aluminum, Black	
<b>Power</b>		
Input voltage	24 V DC (18 to 32 VDC)	
Power consumption, max	14.4W (HB: 21.6W, SC: 14.4W, HB, SC: 21.6W)	31.2W (HB: 33.6W, SC: 31.2W, HB SC: 33.6W)
Input fuse	Internal DC fuse	
<b>System</b>		
CPU	i.MX6Solo Single Cortex-A9 1.0GHz 512kBL2cache (HB, HB SC: Quad ARM Cortex-A9, SC: Dual Cortex-A9)	i.MX6DualLite, Dual Cortex-A9 1.0GHz 512kBL2cache (i.MX6Quad, Quad ARM Cortex-A9 1.0GHz 1MBL2cache)
RAM	512 MB (HB, HB SC: 2 GB, SC: 1 GB)	1 GB (2 GB)
FLASH	2GB SSD(eMMC), 1.5GB free for application storage	
<b>Display</b>		
Size diagonal	7" diagonal	15.4" diagonal
Resolution	800 x 480 pixels	1280 x 800 pixels
Backlight	LED Backlight	
Backlight life time	50 000 hours	50 000 hours (HB, HB SC: 30 000 hours)
Backlight brightness	500 cd/m <sup>2</sup> (HB, HB SC: 1 000 cd/m <sup>2</sup> )	450 cd/m <sup>2</sup> (HB, HB SC: 1 000 cd/m <sup>2</sup> )
Backlight dimming	Marine optimized dimming	Marine optimized dimming
Display type	TFT-LCD with LED backlight	
<b>Softcontrol</b>		
CODESYS runtime version	NA (HB: NA, SC: 3.5, HB SC: 3.5)	NA (HB: NA, SC: 3.5, HB SC: 3.5)
CODESYS EtherCAT	NA (HB: NA, SC: Yes, HB SC: Yes)	NA (HB: NA, SC: Yes, HB SC: Yes)
CODESYS Modbus Ethernet	NA (HB: NA, SC: Yes, HB SC: Yes)	NA (HB: NA, SC: Yes, HB SC: Yes)
CODESYS Modbus RTU	NA (HB: NA, SC: Yes, HB SC: Yes)	NA (HB: NA, SC: Yes, HB SC: Yes)
CANopen	NA (HB: NA, SC: Yes, HB SC: Yes)	NA (HB: NA, SC: Yes, HB SC: Yes)
Non volatile variables	NA (HB: NA, SC: 32KB, HB SC: 64KB)	NA (HB: NA, SC: 64KB, HB SC: 64KB)
<b>Digital IO</b>		
Digital output	NA (HB, HB SC: 2xDO Solid state relay, 0.5A@24VDC)	
<b>Communication serial</b>		
Number of serial ports	1 Port 9pin DSUB	
Serial port 1	RS 232 (RTS/CTS)	
Serial port 2	RS422/485	
Serial port 3	RS485 (only if COM 2 is RS485)	
<b>Ethernet communication</b>		
Number of ethernet ports	1 (HB, SC, HB SC: 2)	2
Ethernet port 1	1x 10/100 Base-T (shielded RJ45)	
Ethernet port 2	NA (HB/SC/HB SC: 1x10/100 Base-T - shielded RJ45)	1x 10/100 Base-T (shielded RJ45)
<b>Expansion interface</b>		
Expansion port	Yes, ciX expansion module	
SD card	SD and SDHC	
USB	1xUSB 2.0 500mA (HB/HB SC: 2xUSB 2.0 500mA)	2 x USB 2.0 500mA
<b>Environmental</b>		
Operating temperature	-10°C to +60°C	
Storage temperature	-20°C to +70°C	
Shock	15g, half-sine, 11ms according to IEC60068-2-27	
Vibration	1g, according to IEC 60068-2-6, Test Fc	
Sealing front	IP65, NEMA 4X/12 and UL Type 4X/12	
Sealing back	IP20	
Humidity	5% – 85% non-condensed	



	X2 pro 4	X2 pro 7 (2eth)
<b>General description</b>		
Part number	630000105	630000205 (630009405)
Warranty	2 year	
<b>Certifications</b>		
General	CE, FCC, KCC	
Marine	BV, DNV GL, KR, LR, ABS, CCS, NK	BV, DNV GL, KR, LR, ABS, CCS, NK (NA)
UL	UL 61010-2-201	
<b>Mechanical</b>		
Mechanical size	145 × 104 × 50 mm	204 × 143 × 50 mm
Touch type	Resistive	
Cut-out size	130 × 89 mm	189 × 128 mm
Weight	0.5 kg	0.8 kg
Housing material	Powder-coated aluminum, Gray	
<b>Power</b>		
Input voltage	24 VDC (18 to 32 VDC)	
Power consumption, max	12W	14.4W
Input fuse	Internal DC fuse	
<b>System</b>		
CPU	i.MX6Solo Single Cortex-A9 1.0GHz 512kBL2cache	i.MX6Solo Single Cortex-A9 1.0GHz 512kBL2cache (i.MX6DualLite, Dual Cortex-A9 1.0GHz 512kBL2cache)
RAM	512 MB	512 MB (1 GB)
FLASH	2GB SSD(eMMC), 1.5GB free for application storage	
<b>Display</b>		
Size diagonal	4.3" diagonal	7" diagonal
Resolution	480 × 272 pixels	800 × 480 pixels
Backlight	LED Backlight	
Backlight life time	50 000 hours	20 000 hours
Backlight brightness	300 cd/m <sup>2</sup>	350 cd/m <sup>2</sup>
Backlight dimming	Industrial Dimming	
Display type	TFT-LCD with LED backlight	
<b>IOs</b>		
Digital output	2xDO Solid state relay, 0.5A@24VDC	
<b>Communication serial</b>		
Number of serial ports	1 Port 9pin DSUB	
Serial port 1	RS 232 (RTS/CTS)	
Serial port 2	RS422/485	
Serial port 3	RS485 (only if COM 2 is RS485)	
<b>Ethernet communication</b>		
Number of ethernet ports	1	1 (2)
Ethernet port 1	1 × 10/100 Base-T (shielded RJ45)	
Ethernet port 2	NA	
<b>Expansion interface</b>		
Expansion port	Yes	
SD card	SD and SDHC	
USB	1 × USB 2.0 500mA	
<b>Environmental</b>		
Operating temperature	-10°C to +60°C	
Storage temperature	-20°C to +70°C	
Shock	15g, half-sine, 11ms according to IEC60068-2-27	
Vibration	1g, according to IEC 60068-2-6, Test Fc	
Sealing front	IP66, NEMA 4X/12 and UL Type 4X/12	IP65, NEMA 4X/12 and UL Type 4X/12
Sealing back	IP20	
Humidity	5% – 85% non-condensed	



X2 pro 10	X2 pro 12	X2 pro 15	X2 pro 21
630000305	640000205	640000305	640009505
2 year		2 year	
CE, FCC, KCC			CE, FCC, KCC
BV, DNV GL, KR, LR, ABS, CCS, NK			NA
UL 61010-2-201			
292 × 194 × 52mm	340 × 242 × 57 mm	410 × 286 × 61mm	556 × 347 × 65mm
Resistive			
275 × 177mm	324 × 226mm	394 × 270mm	539 × 331mm
1.65 kg	2.6 kg	3.85 kg	7,38 kg
Powder-coated aluminum, Gray			
24 V DC (18 to 32 VDC)			
21.6W	28.8W	31.2W	45,6W
Internal DC fuse			
i.MX6DualLite, Dual Cortex-A9 1.0GHz 512kBL2cache			i.MX6Quad, Quad ARM Cortex-A9 1.0GHz 1MBL2cache
1 GB			2 GB
2GB SSD(eMMC), 1.5GB free for application storage			
10.1" diagonal	12.1" diagonal	15.4" diagonal	21,5" diagonal
1024 × 600 pixels	1280 × 800 pixels	1280 × 800 pixels	1920 × 1080 pixels
LED Backlight			
50 000 hours			
500 cd/m <sup>2</sup>	400 cd/m <sup>2</sup>	450 cd/m <sup>2</sup>	250 cd/m <sup>2</sup>
Industrial Dimming			
TFT-LCD with LED backlight			
			2xDO Solid state relay, 0.5A@24VDC
1 Port 9pin DSUB			
RS 232 (RTS/CTS)			
RS422/485			
RS485 (only if COM 2 is RS485)			
2			
1 × 10/100 Base-T (shielded RJ45)			
1 × 10/100 Base-T (shielded RJ45)			
Yes			
SD and SDHC			
2 × USB 2.0 500mA			
-10°C to +60°C		0°C to +50°C	
-20°C to +70°C		-20°C to +60°C	
15g, half-sine, 11ms according to IEC60068-2-27			
1g, according to IEC 60068-2-6, Test Fc			
IP65, NEMA 4X/12 and UL Type 4X/12			
IP20			
5% – 85% non-condensed			



	X2 control 4	X2 control 7
<b>General description</b>		
Part number	630001705	630001805
Warranty	2 year	
<b>Certifications</b>		
General	CE, FCC, KCC	
Marine	BV, DNV GL, KR, LR, ABS, CCS, NK	
UL	UL 61010-2-201	
<b>Mechanical</b>		
Mechanical size	145 × 104 × 50mm	204 × 143 × 50mm
Touch type	Resistive	
Cut-out size	130 × 89mm	189 × 128mm
Weight	0.5 kg	0.8 kg
Housing material	Powder-coated aluminum, Gray	
<b>Power</b>		
Input voltage	24 V DC (18 to 32 VDC)	
Power consumption, max	12W	14.4W
Input fuse	Internal DC fuse	
<b>System</b>		
CPU	i.MX6DualLite, Dual Cortex-A9 1.0GHz 512kBL2cache	
RAM	1 GB	
FLASH	2GB SSD(eMMC), 1.5GB free for application storage	
<b>Display</b>		
Size diagonal	4.3" diagonal	7" diagonal
Resolution	480 × 272 pixels	800 × 480 pixels
Backlight	LED Backlight	
Backlight life time	50 000 hours	20 000 hours
Backlight brightness	300 cd/m <sup>2</sup>	350 cd/m <sup>2</sup>
Backlight dimming	Industrial Dimming	
Display type	TFT-LCD with LED backlight	
<b>Softcontrol</b>		
CODESYS runtime version	3.5	
CODESYS EtherCAT	Yes	
CODESYS Modbus Ethernet	Yes	
CODESYS Modbus RTU	Yes	
CANopen	Yes	
Non volatile variables	32KB	
<b>Communication serial</b>		
Number of serial ports	1 Port 9pin DSUB	
Serial port 1	RS 232 (RTS/CTS)	
Serial port 2	RS422/485	
Serial port 3	RS485 (only if COM 2 is RS485)	
<b>Ethernet communication</b>		
Number of ethernet ports	2	
Ethernet port 1	1 × 10/100 Base-T (shielded RJ45)	
Ethernet port 2	1 × 10/100 Base-T (shielded RJ45)	
<b>Expansion interface</b>		
Expansion port	Yes	
SD card	SD and SDHC	
USB	1 × USB 2.0 500mA	
<b>Environmental</b>		
Operating temperature	-10°C to +60°C	
Storage temperature	-20°C to +70°C	
Shock	15g, half-sine, 11ms according to IEC60068-2-27	
Vibration	1g, according to IEC 60068-2-6, Test Fc	
Sealing front	IP66, NEMA 4X/12 and UL Type 4X/12	IP65, NEMA 4X/12 and UL Type 4X/12
Sealing back	IP20	
Humidity	5% – 85% non-condensed	



	X2 control 10	X2 control 12	X2 control 15
<b>General description</b>			
Part number	630001905	640002205	640002405
Warranty	2 year		
<b>Certifications</b>			
General	CE, FCC, KCC		
Marine	BV, DNV GL, KR, LR, ABS, CCS, NK		
UL	UL 61010-2-201		
<b>Mechanical</b>			
Mechanical size	292 × 194 × 52 mm	340 × 242 × 57 mm	410 × 286 × 61 mm
Touch type	Resistive		
Cut-out size	275 × 177 mm	324 × 226 mm	394 × 270 mm
Weight	1.65 kg	2.6 kg	3.85 kg
Housing material	Powder-coated aluminum, Gray		
<b>Power</b>			
Input voltage	24 V DC (18 to 32 VDC)		
Power consumption, max	21.6W	28.8W	31.2W
Input fuse	Internal DC fuse		
<b>System</b>			
CPU	i.MX6Quad, Quad ARM Cortex-A9 1.0GHz 1MBL2cache		
RAM	2 GB		
FLASH	2GB SSD(eMMC), 1.5GB free for application storage		
<b>Display</b>			
Size diagonal	10.1" diagonal	12.1" diagonal	15.4" diagonal
Resolution	1024 × 600 pixels	1280 × 800 pixels	1280 × 800 pixels
Backlight	LED Backlight		
Backlight life time	50 000 hours		
Backlight brightness	500 cd/m <sup>2</sup>	400 cd/m <sup>2</sup>	450 cd/m <sup>2</sup>
Backlight dimming	Industrial Dimming		
Display type	TFT-LCD with LED backlight		
<b>Softcontrol</b>			
CODESYS runtime version	3.5		
CODESYS EtherCAT	Yes		
CODESYS Modbus Ethernet	Yes		
CODESYS Modbus RTU	Yes		
CANopen	Yes		
Non volatile variables	64KB		
<b>Communication serial</b>			
Number of serial ports	1 Port 9pin DSUB		
Serial port 1	RS232 (RTS/CTS)		
Serial port 2	RS422/485		
Serial port 3	RS485 (only if COM 2 is RS485)		
<b>Ethernet communication</b>			
Number of ethernet ports	2		
Ethernet port 1	1 × 10/100 Base-T (shielded RJ45)		
Ethernet port 2	1 × 10/100 Base-T (shielded RJ45)		
<b>Expansion interface</b>			
Expansion port	Yes		
SD card	SD and SDHC		
USB	2 × USB 2.0 500mA		
<b>Environmental</b>			
Operating temperature	-10°C to +60°C		
Storage temperature	-20°C to +70°C		
Shock	15g, half-sine, 11ms according to IEC60068-2-27		
Vibration	1g, according to IEC 60068-2-6, Test Fc		
Sealing front	IP65, NEMA 4X/12 and UL Type 4X/12		
Sealing back	IP20		
Humidity	5% – 85% non-condensed		

**Technical data – X2 extreme, panel mount versions**

Standard versions, high performance versions (HP) and high-performance versions with integrated CODESYS PLC functionality (HP SC)



	X2 extreme 7	X2 extreme 7 12V	X2 extreme 7 HP (HP SC)
<b>General description</b>			
Part number	640013905	640014005	640014105 (HP SC: 640016005)
Warranty	2 year		
<b>Certifications</b>			
General	CE, FCC, KCC, UL 61010-2-201, UL 746C (UV protection)		
Hazardous	UL Class I Div 2, ATEX/IECEx Zone 2,2		
Marine	DNV GL, KR, LR, ABS, CCS, BV, NK		
<b>Mechanical</b>			
Mechanical size	204 x 143 x 62mm		
Touch type	Resistive		
Touch surface	Polyester on glass, ITO film		
Touch operations	1million finger touch operations		
Cut-out size	189 x 128mm		
Weight	0.8 kg		
Housing material	Powder-coated aluminum, Black		
<b>Power</b>			
Input voltage	24 V DC (18 to 32 VDC)	12 V DC (9 to 16 VDC)	24 V DC (18 to 32 VDC)
Power consumption	10W	11W	17W (HP SC: 17W)
Input fuse	Internal DC fuse		
<b>System</b>			
CPU	i.MX6DualLite, Dual Cortex-A9 800MHz 512kBL2cache		i.MX6Quad, Quad ARM Cortex-A9 1.0GHz 1MBL2cache
RAM	1 GB		2 GB
FLASH	2GB SSD(eMMC), 1.5GB free for application		4GB SSD(eMMC), 3.5GB free for application
<b>Display</b>			
Size diagonal	7" diagonal		
Resolution	800x480 pixels		
Backlight	LED Backlight		
Backlight life time	50 000 hours		100 000 hours
Backlight brightness	500 cd/m²		1 000 cd/m²
Backlight dimming	Marine optimized dimming		
Display type	TFT-LCD with LED backlight		
<b>Softcontrol</b>			
CODESYS runtime version	NA		NA (HP SC: 3.5)
CODESYS EtherCAT	NA		NA (HP SC: Yes)
CODESYS Modbus Ethernet	NA		NA (HP SC: Yes)
CODESYS Modbus RTU	NA		NA (HP SC: Yes)
CANopen	NA		NA (HP SC: Yes)
Non volatile variables	NA		NA (HP SC: Yes)
<b>Communication serial</b>			
Number of serial ports	1 Port 9pin DSUB		2 Port 9pin DSUB
Serial port 1	RS232 (RTS/CTS)		
Serial port 2	RS422/RS485/CAN		
Serial port 3	NA		RS485/CAN
<b>Ethernet communication</b>			
Number of Ethernet ports	1		2
Ethernet port 1	1x10/100 Base-T (shielded RJ45)		
Ethernet port 2	NA		1x10/100 Base-T (shielded RJ45)
<b>Expansion interface</b>			
Expansion port	NA		
SD card	SD and SDHC		
USB	2xUSB 2.0 500mA		
<b>Environmental</b>			
Operating temperature	-30°C to +70°C		
Storage temperature	-40°C to +80°C		
Shock	40g, half-sine, 11ms according to IEC60068-2-27		
Vibration	4g, according to IEC 60068-2-6, Test Fc		
Sealing front	IP66, NEMA 4X/12 and UL Type 4X/12		
Sealing back	IP20		
Humidity	5% – 95% non-condensed		



	X2 extreme 12	X2 extreme 12 HP (HP SC)	X2 extreme 15	X2 extreme 15 HP (HP SC)
Part number	640014305	640014405 (HP SC: 640016405)	640014605	640014705 (HP SC: 640016805)
Warranty	2 year		2 year	
<b>Certifications</b>				
General	CE, FCC, KCC, UL 61010-2-201, UL 746C (UV protection)		CE, FCC, KCC, UL 61010-2-201, UL 746C (UV protection)	
Hazardous	UL Class I Div 2, ATEX/IECEx Zone 2,2		UL Class I Div 2, ATEX/IECEx Zone 2,2	
Marine	DNV GL, KR, LR, ABS, CCS, BV, NK		DNV GL, KR, LR, ABS, CCS, BV, NK	
<b>Mechanical</b>				
Mechanical size	340 x 242 x 69mm		410 x 286 x 73mm	
Touch type	Resistive		Resistive	
Touch surface	Polyester on glass, ITO film		Polyester on glass, ITO film	
Touch operations	1million finger touch operations		1million finger touch operations	
Cut-out size	324 x 226mm		394 x 270mm	
Weight	2.8 kg		4.1 kg	
Housing material	Powder-coated aluminum, Black		Powder-coated aluminum, Black	
<b>Power</b>				
Input voltage	24 V DC (18 to 32 VDC)			
Power consumption	16W	23W (HP SC: 23W)	18W	28W (HP SC: 28W)
Input fuse	Internal DC fuse			
<b>System</b>				
CPU	i.MX6DualLite, Dual Cortex-A9 800MHz 512kBL2cache	i.MX6Quad, Quad ARM Cortex-A9 1.0GHz 1MBL2cache	i.MX6DualLite, Dual Cortex-A9 800MHz 512kBL2cache	i.MX6Quad, Quad ARM Cortex-A9 1.0GHz 1MBL2cache
RAM	1 GB	2 GB	1 GB	2 GB (HP SC: 2 GB)
FLASH	2GB SSD(eMMC), 1.5GB free for application	4GB SSD(eMMC), 3.5GB free for application	2GB SSD(eMMC), 1.5GB free for application	4GB SSD(eMMC), 3.5GB free for application
<b>Display</b>				
Size diagonal	12.1" diagonal		15.4" diagonal	
Resolution	1280x800 pixels		1280x800 pixels	
Backlight	LED Backlight		LED Backlight	
Backlight life time	100 000 hours		100 000 hours	
Backlight brightness	500 cd/m²	1 000 cd/m²	450 cd/m²	1 000 cd/m²
Backlight dimming	Marine optimized dimming		Marine optimized dimming	
Display type	TFT-LCD with LED backlight		TFT-LCD with LED backlight	
<b>Softcontrol</b>				
CODESYS runtime version	NA		NA (HP SC: 3.5)	
CODESYS EtherCAT	NA		NA (HP SC: Yes)	
CODESYS Modbus Ethernet	NA		NA (HP SC: Yes)	
CODESYS Modbus RTU	NA		NA (HP SC: Yes)	
CANopen	NA		NA (HP SC: Yes)	
Non volatile variables	NA		NA (HP SC: Yes)	
<b>Communication serial</b>				
Number of serial ports	1 Port 9pin DSUB		2 Port 9pin DSUB	
Serial port 1	RS232 (RTS/CTS)			
Serial port 2	RS422/RS485/CAN			
Serial port 3	NA		RS485/CAN	
<b>Ethernet communication</b>				
Number of Ethernet ports	1		2	
Ethernet port 1	1x10/100 Base-T (shielded RJ45)			
Ethernet port 2	NA		1x10/100 Base-T (shielded RJ45)	
<b>Expansion interface</b>				
Expansion port	NA			
SD card	SD and SDHC			
USB	2xUSB 2.0 500mA			
<b>Environmental</b>				
Operating temperature	-30°C to +70°C		-30°C to +70°C	
Storage temperature	-40°C to +80°C		-40°C to +80°C	
Shock	40g, half-sine, 11ms according to IEC60068-2-27		40g, half-sine, 11ms according to IEC60068-2-27	
Vibration	4g, according to IEC 60068-2-6, Test Fc		4g, according to IEC 60068-2-6, Test Fc	
Sealing front	IP66, NEMA 4X/12 and UL Type 4X/12		IP66, NEMA 4X/12 and UL Type 4X/12	
Sealing back	IP20			
Humidity	5% – 95% non-condensed			

**Technical data – X2 extreme, fully sealed versions**

High-performance versions (SL HP) and high-performance versions with integrated CODESYS PLC functionality (SL HP SC)



	X2 extreme 7 SL HP	X2 extreme 7 SL HP SC
<b>General description</b>		
Part number	640014205	640016205
Warranty	2 year	
<b>Certifications</b>		
General	CE, FCC, KCC, UL 61010-2-201, UL 746C (UV protection)	
Hazardous	UL Class I Div 2, ATEX/IECEX Zone 2,22	
Marine	DNV GL, KR, LR, ABS, CCS, BV, NK	
<b>Mechanical</b>		
Mechanical size	205 x 160 x 65mm	
Touch type	Resistive	
Touch surface	Polyester on glass, ITO film	
Touch operations	1million finger touch operations	
Weight	1.6 kg	
Housing material	Powder-coated aluminum, Black	
<b>Power</b>		
Input voltage	24 V DC (18 to 32 VDC)	
Power consumption	17 W	
Input fuse	Internal DC fuse	
<b>System</b>		
CPU	i.MX6Quad, Quad ARM Cortex-A9 1.0GHz 1MBL2cache	
RAM	2 GB	
FLASH	4GB SSD(eMMC), 3.5GB free for application	
<b>Display</b>		
Size diagonal	7" diagonal	
Resolution	800x480 pixels	
Backlight	LED Backlight	
Backlight life time	100 000 hours	
Backlight brightness	1 000 cd/m²	
Backlight dimming	Marine optimized dimming	
Display type	TFT-LCD with LED backlight	
<b>Softcontrol</b>		
CODESYS runtime version	NA	3.5
CODESYS EtherCAT	NA	Yes
CODESYS Modbus Ethernet	NA	Yes
CODESYS Modbus RTU	NA	Yes
CANopen	NA	Yes
Non volatile variables	NA	Yes
<b>Communication serial</b>		
Number of serial ports	2 Port 8pin M12	
Serial port 1	RS232 (RTS)	
Serial port 2	RS422/RS485/CAN	
Serial port 3	RS485/CAN	
<b>Ethernet communication</b>		
Number of Ethernet ports	2x4pinM12	
Ethernet port 1	1x10/100 Base-T (M12)	
Ethernet port 2	1x10/100 Base-T (M12)	
<b>Expansion interface</b>		
Expansion port	NA	
SD card	SD and SDHC	
USB	2xUSB 2.0 500mA	
<b>Environmental</b>		
Operating temperature	-30°C to +70°C	
Storage temperature	-40°C to +80°C	
Shock	40g, half-sine, 11ms according to IEC60068-2-27	
Vibration	4g, according to IEC 60068-2-6, Test Fc	
Sealing front	IP66 (IP65 for ATEX/IECEX), NEMA 4X/12 and UL Type 4X/12	
Sealing back	IP20	
Humidity	5% – 95% non-condensed	



	X2 extreme 12 SL HP	X2 extreme 12 SL HP SC	X2 extreme 15 SL HP	X2 extreme 15 SL HP SC
	640014505	640016605	640014805	640017005
Warranty	2 year		2 year	
<b>Certifications</b>				
General	CE, FCC, KCC, UL 61010-2-201, UL 746C (UV protection)		CE, FCC, KCC, UL 61010-2-201, UL 746C (UV protection)	
Hazardous	UL Class I Div 2, ATEX/IECEX Zone 2,22		UL Class I Div 2, ATEX/IECEX Zone 2,22	
Marine	DNV GL, KR, LR, ABS, CCS, BV, NK		DNV GL, KR, LR, ABS, CCS, BV, NK	
<b>Mechanical</b>				
Mechanical size	341 x 243 x 65mm		410 x 286 x 65mm	
Touch type	Resistive		Resistive	
Touch surface	Polyester on glass, ITO film		Polyester on glass, ITO film	
Touch operations	1million finger touch operations		1million finger touch operations	
Weight	3.4 kg		4.8 kg	
Housing material	Powder-coated aluminum, Black		Powder-coated aluminum, Black	
<b>Power</b>				
Input voltage	24 V DC (18 to 32 VDC)		24 V DC (18 to 32 VDC)	
Power consumption	23 W		28 W	
Input fuse	Internal DC fuse		Internal DC fuse	
<b>System</b>				
CPU	i.MX6Quad, Quad ARM Cortex-A9 1.0GHz 1MBL2cache		i.MX6Quad, Quad ARM Cortex-A9 1.0GHz 1MBL2cache	
RAM	2 GB		2 GB	
FLASH	4GB SSD(eMMC), 3.5GB free for application		4GB SSD(eMMC), 3.5GB free for application	
<b>Display</b>				
Size diagonal	12.1" diagonal		15.4" diagonal	
Resolution	1280x800 pixels		1280x800 pixels	
Backlight	LED Backlight		LED Backlight	
Backlight life time	100 000 hours		100 000 hours	
Backlight brightness	1 000 cd/m²		1 000 cd/m²	
Backlight dimming	Marine optimized dimming		Marine optimized dimming	
Display type	TFT-LCD with LED backlight		TFT-LCD with LED backlight	
<b>Softcontrol</b>				
CODESYS runtime version	NA	3.5	NA	3.5
CODESYS EtherCAT	NA	Yes	NA	Yes
CODESYS Modbus Ethernet	NA	Yes	NA	Yes
CODESYS Modbus RTU	NA	Yes	NA	Yes
CANopen	NA	Yes	NA	Yes
Non volatile variables	NA	Yes	NA	Yes
<b>Communication serial</b>				
Number of serial ports	2 Port 8pin M12		2 Port 8pin M12	
Serial port 1	RS232 (RTS)		RS232 (RTS)	
Serial port 2	RS422/RS485/CAN		RS422/RS485/CAN	
Serial port 3	RS485/CAN		RS485/CAN	
<b>Ethernet communication</b>				
Number of Ethernet ports	2x4pinM12		2x4pinM12	
Ethernet port 1	1x10/100 Base-T (M12)		1x10/100 Base-T (M12)	
Ethernet port 2	1x10/100 Base-T (M12)		1x10/100 Base-T (M12)	
<b>Expansion interface</b>				
Expansion port	NA		NA	
SD card	SD and SDHC		SD and SDHC	
USB	2xUSB 2.0 500mA		2xUSB 2.0 500mA	
<b>Environmental</b>				
Operating temperature	-30°C to +70°C		-30°C to +70°C	
Storage temperature	-40°C to +80°C		-40°C to +80°C	
Shock	40g, half-sine, 11ms according to IEC60068-2-27		40g, half-sine, 11ms according to IEC60068-2-27	
Vibration	4g, according to IEC 60068-2-6, Test Fc		4g, according to IEC 60068-2-6, Test Fc	
Sealing front	IP66 (IP65 for ATEX/IECEX), NEMA 4X/12 and UL Type 4X/12		IP66 (IP65 for ATEX/IECEX), NEMA 4X/12 and UL Type 4X/12	
Sealing back	IP20		IP20	
Humidity	5% – 95% non-condensed		5% – 95% non-condensed	



	X2 pro 7 web	X2 pro 10 web	X2 pro 15 web
<b>General description</b>			
Part number	630023505	630023605	640020605
Warranty	2 years		
<b>Certifications</b>			
General	CE, FCC, KCC, UL 61010-2-201		
Hazardous	NA		
Marine	KR, LR, ABS, BV, CCS, NK, DNV GL		
<b>Mechanical</b>			
Mechanical size	204 x 143 x 50mm	292 x 194 x 52mm	410 x 286 x 61mm
Mounting option	Panel mount, VESA 75 x 75		
Number of touches	1million finger touch operations		
Touch type	Resistive		
Cut-out size	189 x 128mm	275 x 177mm	394 x 270mm
Weight	0.8 kg	1.65 kg	3.85 kg
Housing material	Powder-coated aluminum, Gray		
<b>Power</b>			
Input voltage	24 V DC (18 to 32 VDC) CE: The power supply must conform with the requirements according to IEC 60950 and IEC 61558-2-4.UL and cUL: The power supply must conform with the requirements for class II power supplies.		
Power consumption (max)	14.4W	21.6W	31.2W
Input fuse	Internal DC fuse		
<b>System</b>			
CPU	i.MX6DualLite, Dual Cortex-A9 1.0GHz 512kBL2cache	i.MX6Quad, Quad ARM Cortex-A9 1.0GHz 1MBL2cache	i.MX6Quad, Quad ARM Cortex-A9 1.0GHz 1MBL2cache
RAM	1GB	2GB	
FLASH	4GB EMMC		
<b>Software</b>			
Operating system	Linux		
Web browser	Chromium in Kiosk mode		
<b>Display</b>			
Size diagonal	7" diagonal	10.1" diagonal	15.4" diagonal
Resolution	800x480 pixels	1024x600 pixels	1280x800 pixels
Backlight	LED Backlight		
Backlight life time	20000 hours	50000 hours	
Backlight brightness	350 cd/m2	500 cd/m2	450 cd/m2
Backlight dimming	Industrial dimming		
Display type	TFT-LCD with LED backlight		
<b>Communication serial</b>			
Number of serial ports	1 Port 9pin DSUB		
Serial port 1	RS 232 (RTS/CTS)		
Serial port 2	RS422/RS485		
Serial port 3	RS485 (only if COM 2 is RS485)		
<b>Ethernet communication</b>			
Number of Ethernet ports	1	2	
Ethernet port 1	1x10/100 Base-T (shielded RJ45)		
Ethernet port 2	1x10/100 Base-T (shielded RJ45)		
<b>Expansion interface</b>			
SD card	SD and SDHC		
USB	1xUSB 2.0 500mA	2xUSB 2.0 500mA	
<b>Environmental</b>			
Operating temperature	-10°C to +60°		
Storage temperature	-20°C to +70°C		
Shock	15g, half-sine, 11ms according to IEC60068-2-27		
Vibration	1g, according to IEC 60068-2-6, Test Fc		
Sealing front	IP65, NEMA 4X/ 12 and UL Type 4X/ 12		
Sealing back	IP20		
Humidity	5% – 85% non-condensed		



	X2 extreme 7 web	X2 extreme 12 web	X2 extreme 15 web
<b>General description</b>			
Part number	640020705	640020805	640020905
Warranty	2 years		
<b>Certifications</b>			
General	CE, FCC, KCC, UL 61010-2-201, UL 746C		
Hazardous	ULC1D2, ATEX (Zone2), ATEX (Zone22), IEXEx (Zone2), IEXEx (Zone22)		
Marine	KR, LR, ABS, CCS, BV, NK, DNV GL		
<b>Mechanical</b>			
Mechanical size	204 x 143 x 62mm	340 x 242 x 69mm	410 x 286 x 73mm
Mounting option	Panel mount		
Number of touches	1million finger touch operations		
Touch type	Resistive		
Cut-out size	189 x 128mm	324 x 226mm	394 x 270mm
Weight	0.8 kg	2.8 kg	4.1 kg
Housing material	Powder-coated aluminum, Black		
<b>Power</b>			
Input voltage	24 V DC (18 to 32 VDC) CE: The power supply must conform with the requirements according to IEC 60950 and IEC 61558-2-4.UL and cUL: The power supply must conform with the requirements for class II power supplies.		
Power consumption (max)	17 W	23 W	28 W
Input fuse	Internal DC fuse		
<b>System</b>			
CPU	i.MX6Quad, Quad ARM Cortex-A9 1.0GHz 1MBL2cache		
RAM	2 GB		
FLASH	8GB EMMC		
<b>Software</b>			
Operating system	Linux		
Web browser	Chromium in Kiosk mode		
<b>Display</b>			
Size diagonal	7" diagonal	12.1" diagonal	15.4" diagonal
Resolution	800x480 pixels	1280x800 pixels	
Backlight	LED Backlight		
Backlight life time	100000 hours		
Backlight brightness	1000 cd/m2		
Backlight dimming	Marine optimized dimming		
Display type	TFT-LCD with LED backlight		
<b>Communication serial</b>			
Number of serial ports	2 Port 9pin DSUB		
Serial port 1	RS 232 (RTS/CTS)		
Serial port 2	RS422/485		
Serial port 3	RS485/CAN		
<b>Ethernet communication</b>			
Number of Ethernet ports	2		
Ethernet port 1	1x10/100 Base-T (shielded RJ45)		
Ethernet port 2	1x10/100 Base-T (shielded RJ45)		
<b>Expansion interface</b>			
Expansion port			
SD card	SD and SDHC		
USB	2xUSB 2.0 500mA		
<b>Environmental</b>			
Operating temperature	-30°C to +70°C		
Storage temperature	-40°C to +80°C		
Shock	40g, half-sine, 11ms according to IEC60068-2-27		
Vibration	4g, according to IEC 60068-2-6, Test Fc		
Sealing front	IP66, NEMA 4X/ 12 and UL Type 4X/ 12		
Sealing back	IP20		
Humidity	5% – 95% non-condensed		



# A simple path forward

It's easy to upgrade your existing iX HMI solution

Continues on next page ...

## Hardware upgrade to X2 series

Use the migration tables to find the right panel when you want to upgrade your existing iX HMI solution to the X2 panel series.

### From iX HMI Industrial to X2 pro

iX HMI panel	X2 panel	Comment
iX T4A	X2 pro 4	-
iX T7A	X2 pro 7	-
iX T10A	X2 pro 10	Different cut-out size
iX T7B	X2 pro 7	-
iX T12B	X2 pro 12	-
iX T15B	X2 pro 15	-
-	X2 pro 21	-

### From iX HMI Marine to X2 marine

iX HMI panel	X2 panel	Comment
iX T7AM	X2 marine 7	-
-	X2 marine 7 HB	-
-	X2 marine 7 SC	New 7-inch panel with integrated control
-	X2 marine 7 HB SC	New 7-inch panel with integrated control and high brightness display
iX T15BM	X2 marine 15	-
iX T15BM-HB	X2 marine 15 HB	-
-	X2 marine 15 SC	New 15-inch panel with integrated control
-	X2 marine 15 HB SC	New 15-inch panel with integrated control and high brightness display

### From iX HMI SoftControl to X2 control

iX HMI panel	X2 panel	Comment
iX T4A-SC	X2 control 4	-
iX T7A-SC	X2 control 7	-
iX T10A-SC	X2 control 10	Different cut-out size
iX T7B-SC	X2 control 7	-
iX T12B-SC	X2 control 12	-
iX T15B-SC	X2 control 15	-

### From iX HMI TxF-2 series to X2 base

iX HMI panel	X2 panel	Comment
iX T5F-2	X2 base 5	-
iX T7F-2	X2 base 7	-
iX T10F-2	X2 base 10	-

## Serial port layout

### TxA

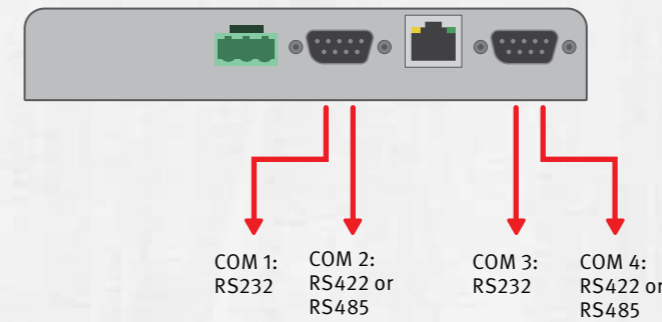

### TxB

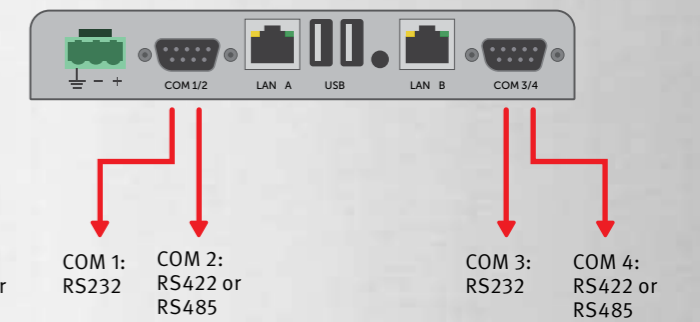

### X2 pro 4 and X2 pro 7

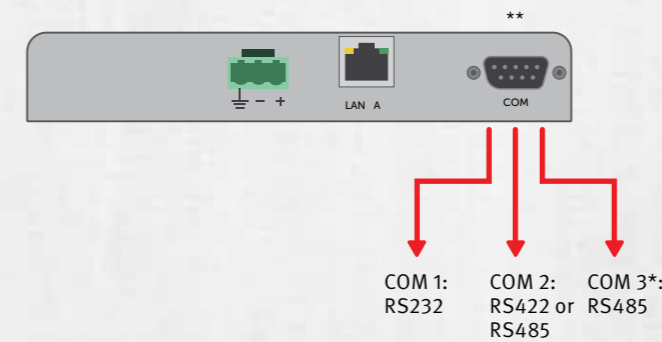

### X2 pro 10, X2 pro 12 and X2 pro 15

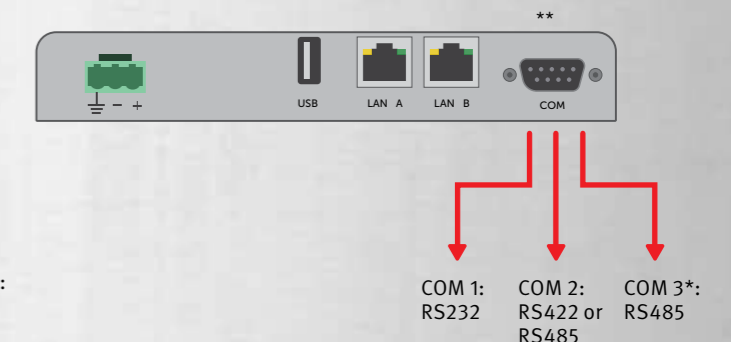

\* COM3 can only be used if COM2 is RS485

\* COM3 can only be used if COM2 is RS485

\*\* CAB150 splitter cable provides the connectivity for the three serial ports.



If you use COM3 for RS232 in TxA or TxB:

- Change to COM 1

If you use 2 × RS485:

- Change COM4 to COM3
- COM 2 needs to be RS485

## iX application upgrade



X2 panels are software compatible with iX 2.20 SP2 and forwards. Watch the video on [www.beijerelectronics.com/X2](http://www.beijerelectronics.com/X2) to see how easily you update an existing iX application to an X2 panel.

## OPC DA communication

- OPC DA communication is not supported in X2 platform
- Change to OPC UA instead



... continued from previous page.

Hardware upgrade to X2 series

Use the migration tables to find the right panel when you want to upgrade your existing iX HMI solution to the X2 panel series.

From QTERM-Ax to X2 extreme

QTERM panel	X2 panel	Comment
QTERM-A7 iX	X2 extreme 7	Different cut-out size
QTERM-A7 Qlarity	X2 extreme 7	Different cut-out size, new HMI software
QTERM-G72	X2 extreme 7	Different cut-out size, new HMI software
QTERM-A12 iX	X2 extreme 12	Different cut-out size, different aspect ratio
QTERM-A12 Qlarity	X2 extreme 12	Different cut-out size, different aspect ratio, new HMI software

From iX TxBR to X2 extreme

iX TxBR panel	X2 panel	Comment
iX T7BR	X2 extreme 7	-
iX T7BR HB HP	X2 extreme 7 HP	-
-	X2 extreme 7 SL HP	New 7-inch rugged fully sealed high-performance panel
-	X2 extreme 7 HP SC	New 7-inch rugged high-performance panel with integrated control
-	X2 extreme 7 SL HP SC	New 7-inch rugged fully sealed high-performance panel with integrated control
iX T15BR	X2 extreme 15	-
iX T15BR HB HP	X2 extreme 15 HP	-
-	X2 extreme 15 SL HP	New 15-inch rugged fully sealed high-performance panel
-	X2 extreme 15 HP SC	New 15-inch rugged high-performance panel with integrated control
-	X2 extreme 15 SL HP SC	New 15-inch rugged fully sealed high-performance panel with integrated control

Serial port layout

QTERM-Ax

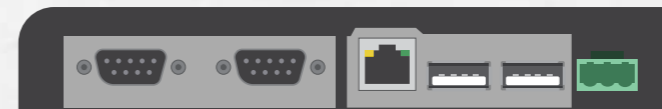

COM 1:  
RS232 or  
RS485 or  
RS422

COM 2:  
RS232

TxBR



COM 1:  
RS232

COM 2:  
RS485 or  
RS422

X2 extreme x HP, HC

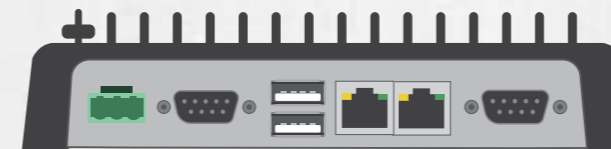

COM 3:  
RS485

CAN\*\*:  
CAN2  
Isolated

Com1:  
RS232

Com2:  
RS422 or  
RS485

CAN\*:  
CAN1

\*CAN1 can only be used if COM2 is not used  
\*\*CAN2 can only be used if COM3 is not used

X2 extreme x

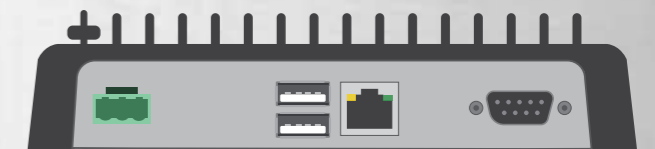

Com1:  
RS232

Com2:  
RS422  
or  
RS485

Com3\*:  
RS485

CAN\*\*:  
CAN1  
CAN2

\*COM3 can only be used if COM2 is RS485  
\*\*CAN1 can only be used if COM2 is not used  
\*\*CAN2 can only be used if COM3 is not used

iX application upgrade



X2 panels are software compatible with iX 2.20 SP2 and forwards. Watch the video on [www.beijerelectronics.com/X2](http://www.beijerelectronics.com/X2) to see how easily you update an existing iX application to an X2 panel.

OPC DA communication

- OPC DA communication is not supported in X2 platform
- Change to OPC UA instead



## About Beijer Electronics

Beijer Electronics is a multinational, cross-industry innovator that connects people and technologies to optimize processes for business-critical applications. Our offer includes operator communication, automation solutions, digitalization, display solutions and support. As experts in user-friendly software, hardware and services for the Industrial Internet of Things, we empower you to meet your challenges through leading-edge solutions.

Beijer Electronics is a Beijer Group company. Beijer Group has a sale over 1.6 billion SEK in 2019 and is listed on the NASDAQ OMX Nordic Stockholm Small Cap list under the ticker BELE. [www.beijergroup.com](http://www.beijergroup.com)

### CHINA

Shanghai

### ITALY

Parma

### TAIWAN

Taipei

### DENMARK

Roskilde

### NORWAY

Drammen

### TURKEY

Istanbul

### FRANCE

Paris

### SOUTH KOREA

Seoul

### UNITED KINGDOM

Nottingham

### GERMANY

Nürtingen

### SWEDEN

Göteborg

Malmö

Stockholm

### USA

Salt Lake City



#### Head office

Beijer Electronics AB  
Box 426, Stora Varvsgatan 13a  
SE-201 24 Malmö, Sweden

[www.beijerelectronics.com](http://www.beijerelectronics.com) | +46 40 35 86 00

#### Omni Ray AG

Im Schörl 5 | CH-8600 Dübendorf  
Telefon +41 44 802 28 80  
Fax +41 44 802 28 28  
[info@omniray.ch](mailto:info@omniray.ch)  
[www.omniray.ch](http://www.omniray.ch)

**Omni Ray**  
Power of Automation